



CITY

60359





[LEGO.com/sustainable-packaging](https://LEGO.com/sustainable-packaging)



# BUILDER



Apple and the Apple logo are trademarks of Apple Inc., registered in the U.S. and other countries and regions. App Store is a service mark of Apple Inc. Google Play and the Google Play logo are trademarks of Google LLC. Tencent and the Tencent logo are trademarks of Tencent Inc.

**EN** Ask parents' permission before going online | **DE** Eltern um Erlaubnis bitten, bevor du online gehst | **FR** Demande l'autorisation d'un parent avant d'aller en ligne | **IT** Chiedi il permesso ai tuoi genitori prima di andare online | **ES** Pídeles permiso a tus papás antes de conectarte a Internet | **PT** Pede autorização aos pais antes de acederes online | **JA** オンラインになる前に ほか者の方のきよかをもらおう | **ZH** 上网前应先征得父母的同意 | **KO** 온라인 접속 전에 보호자 동의가 필요합니다 | **RU** Спроси разрешения у родителей, прежде чем заходить в интернет | **PL** Poproś rodziców o zgodę, zanim wejdiesz do Internetu | **CS** Než půjdeš na internet, požádej rodiče o svolení | **SK** Skôr než pôjdeš na internet, vypýtaj si povolenie od rodičov | **HU** Kérj szülői engedélyt, mielőtt online csatlakoznál! | **RO** Cere permisiunea părinților înainte de a te conecta online | **BG** Поискайте разрешение от родител, преди да влезете онлайн | **LV** Pirms došanās tiešsaistē palūdz atļauju vecākiem | **ET** Enne Interneti kasutamist küsi vanematelt luba | **LT** Prieš prisijungdami prie interneto, atsklauskite tėvų

[LEGO.com/devicecheck](https://www.lego.com/devicecheck)

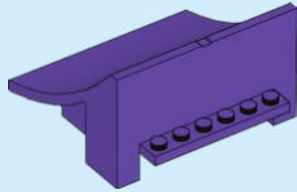
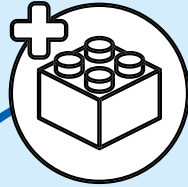

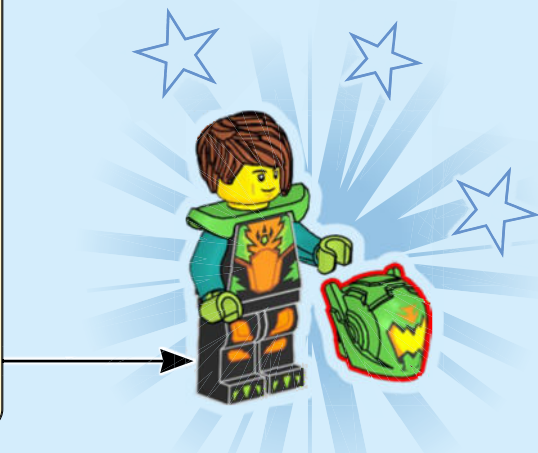
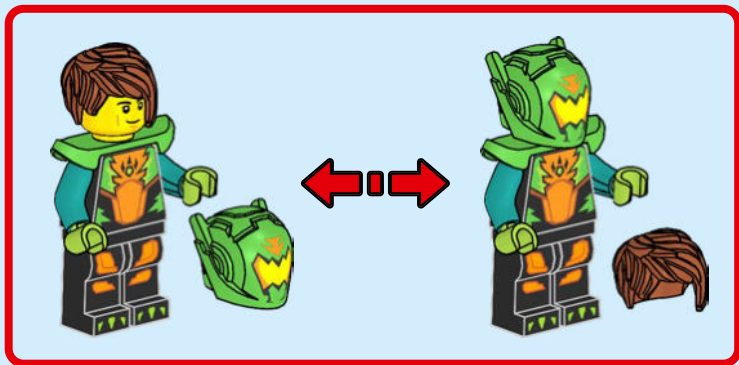
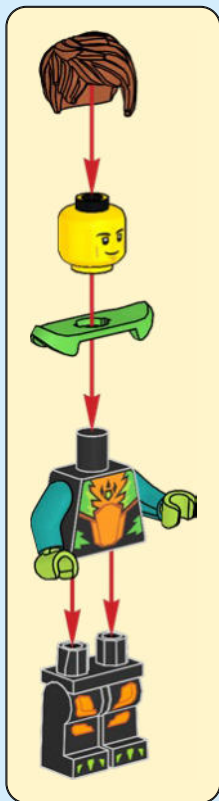

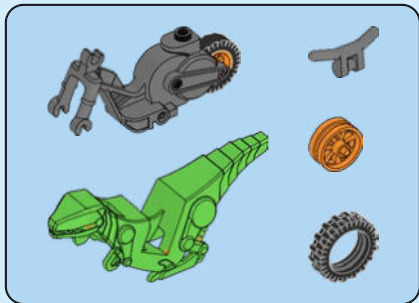

1

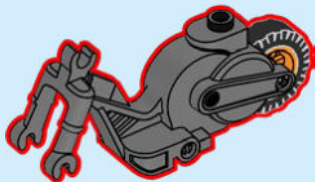

2

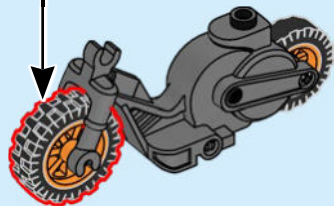

3

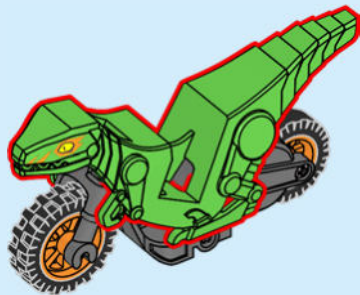

4



1



← ... x3

2





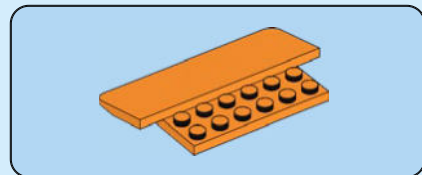
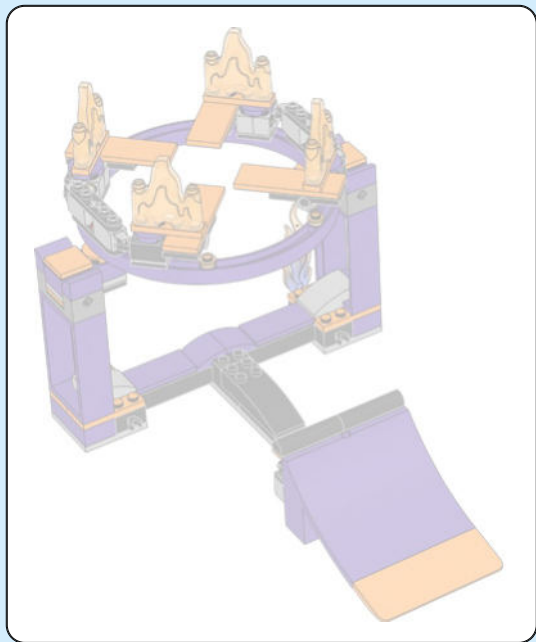

1

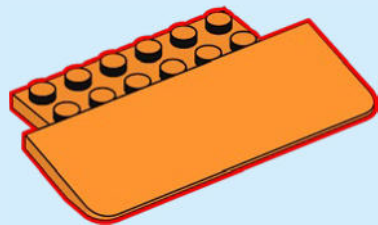

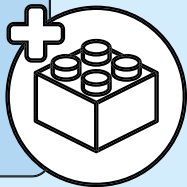
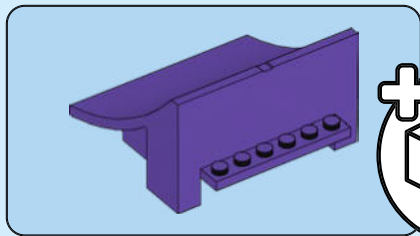

2

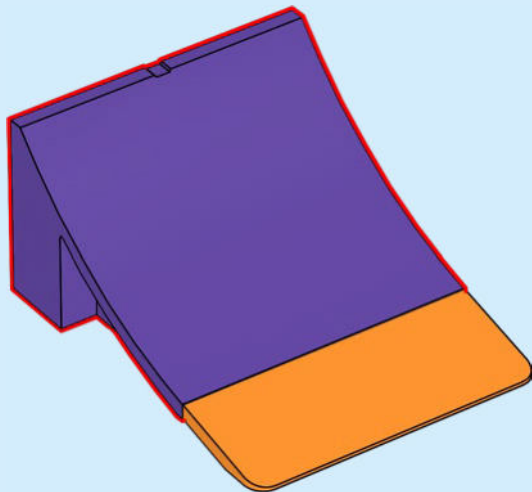



3

1



2

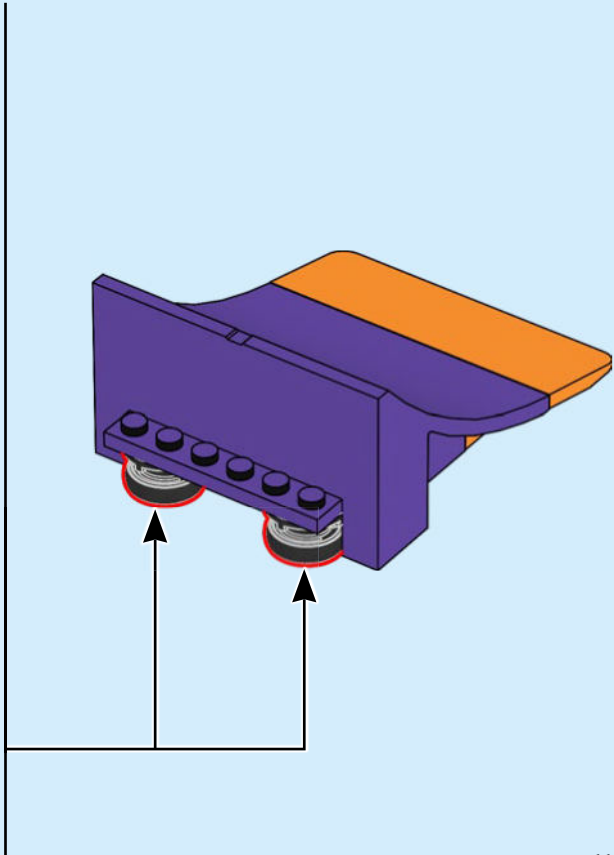
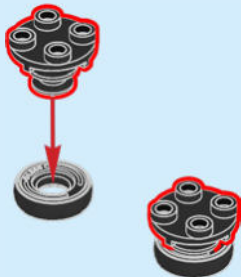

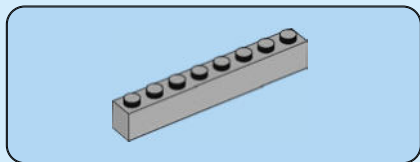
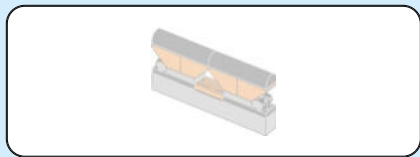

4

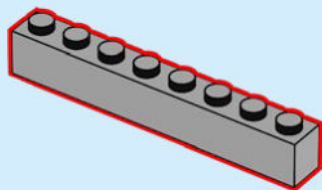

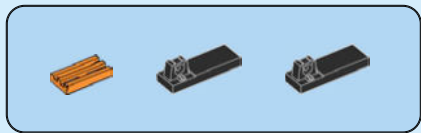

5

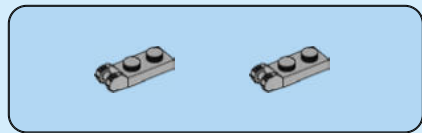
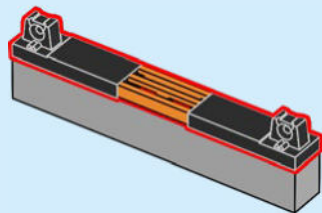

6

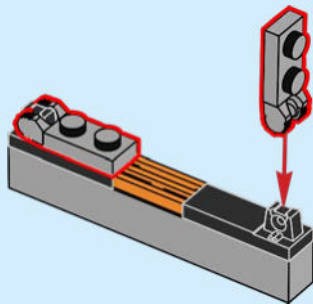

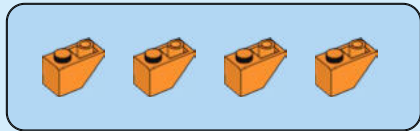

7

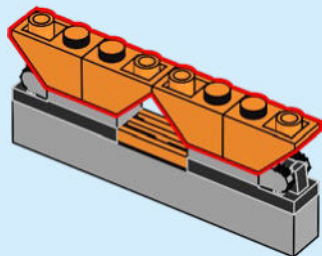

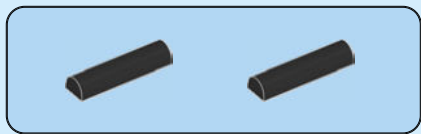

8



9

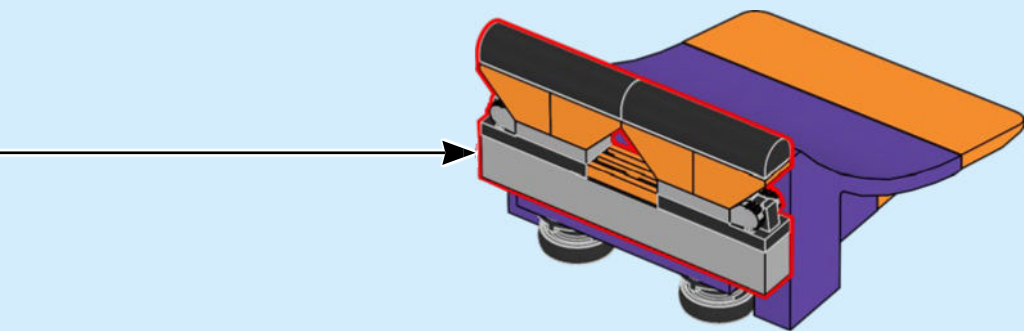



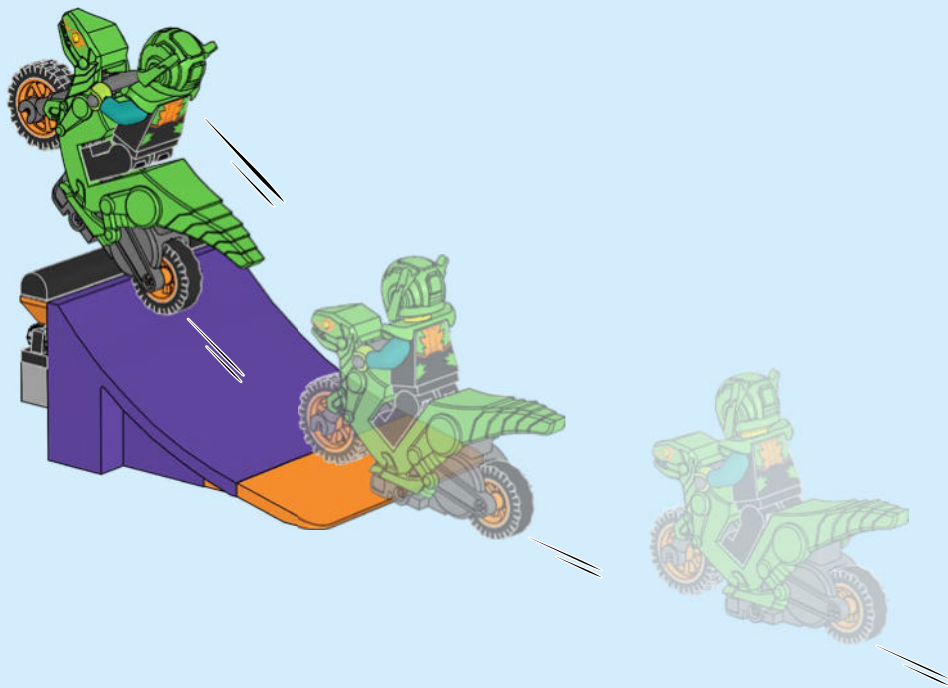

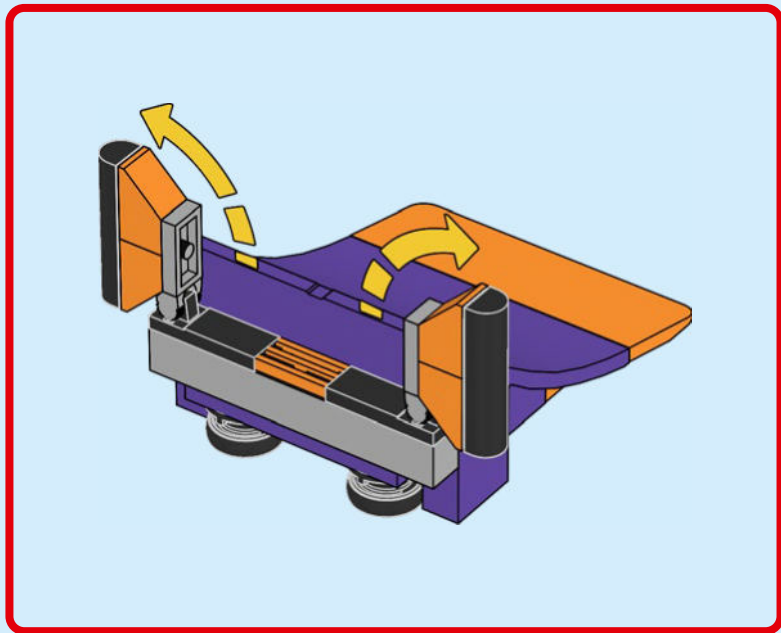

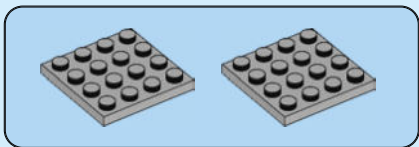
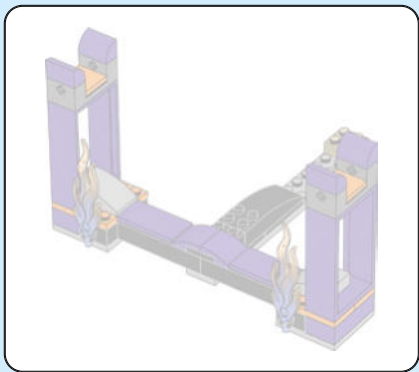

10

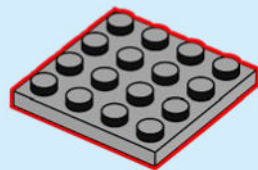

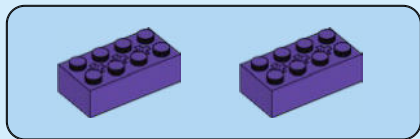

11

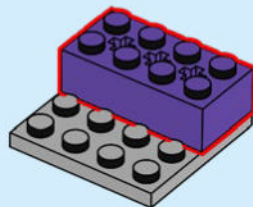
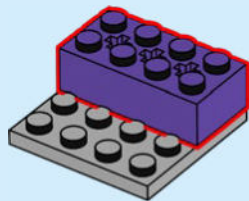

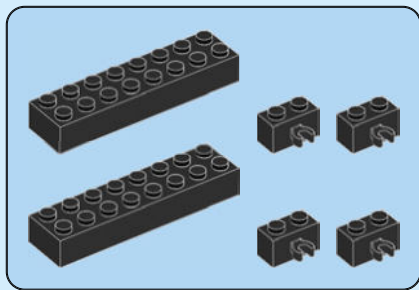

12

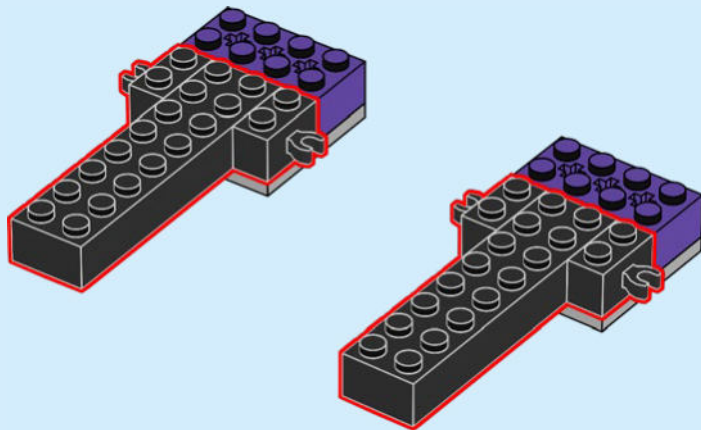

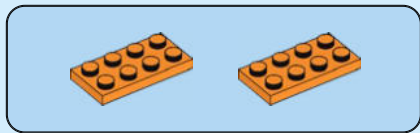

13

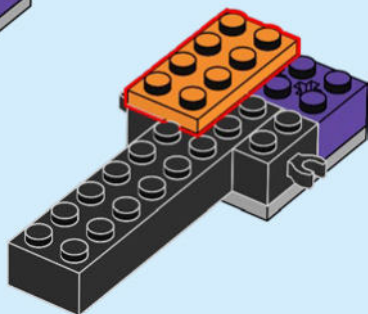
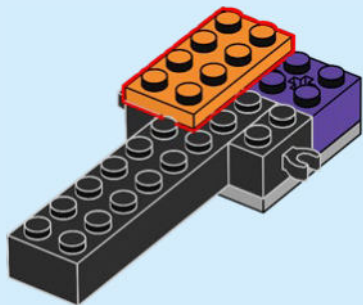

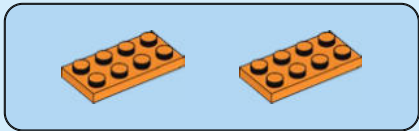

14

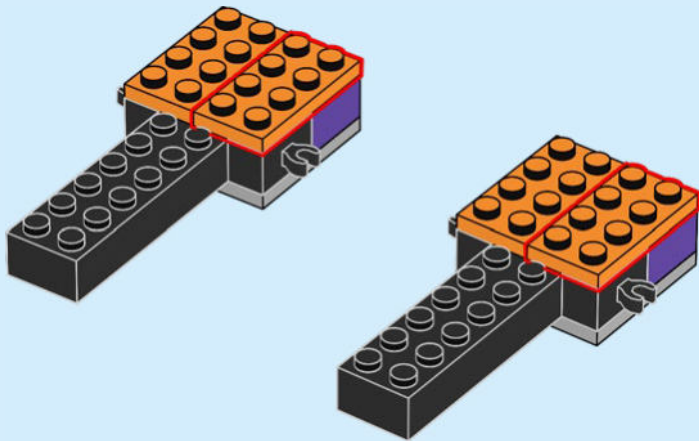

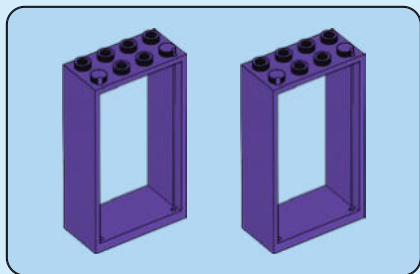

15

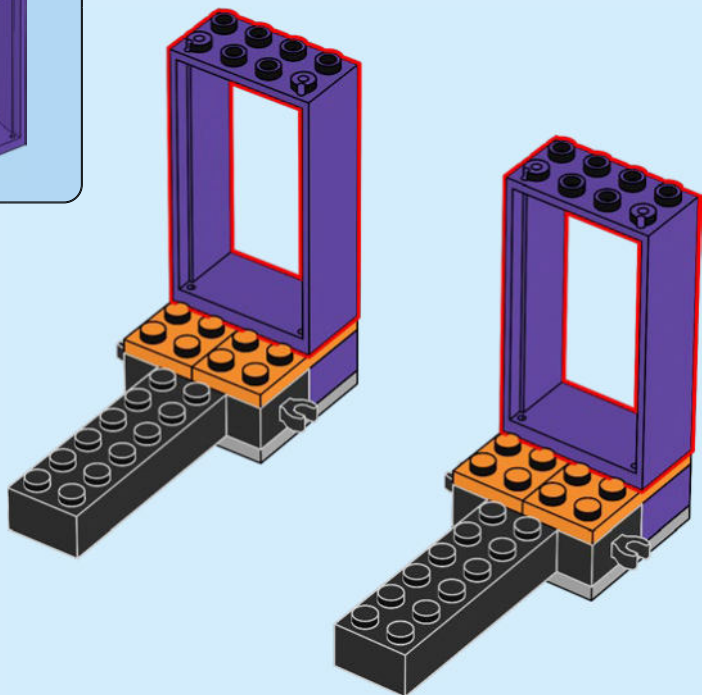



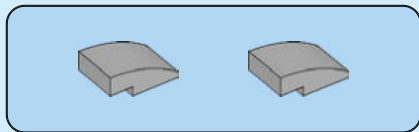

16

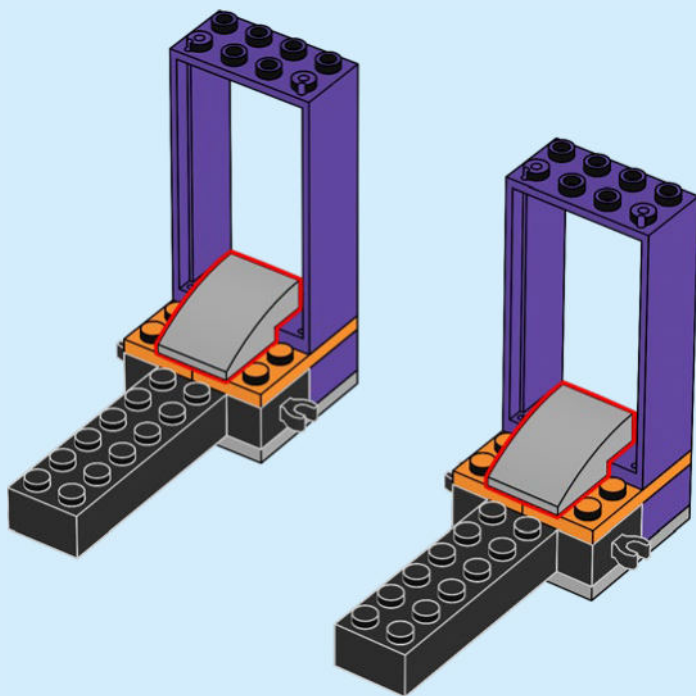

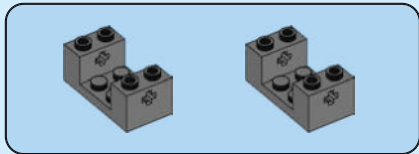

17

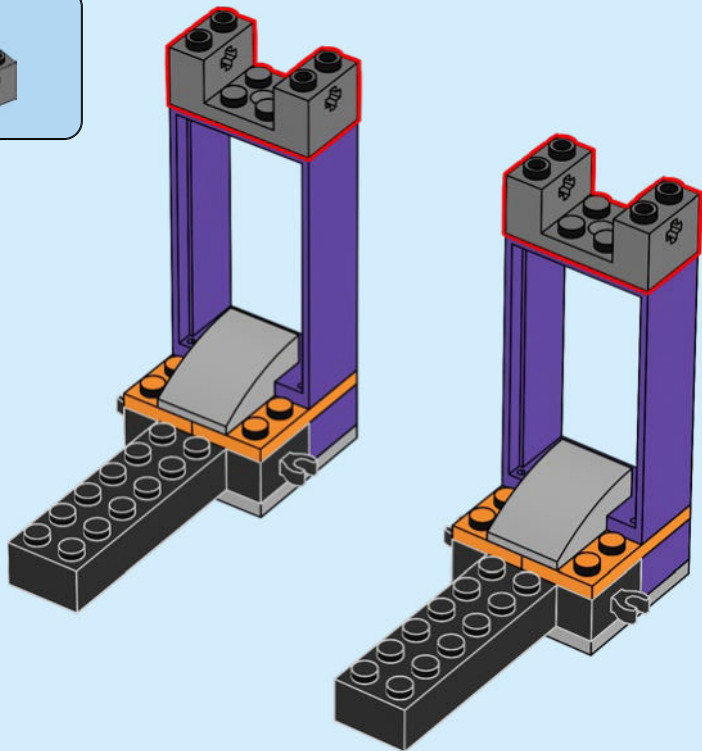

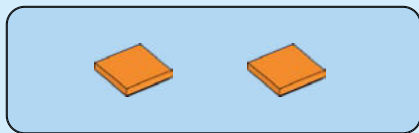

18

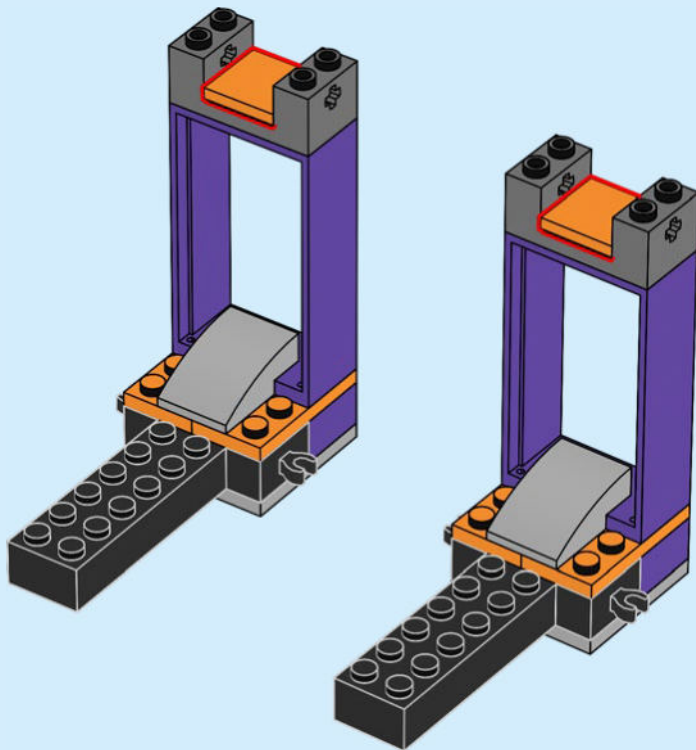

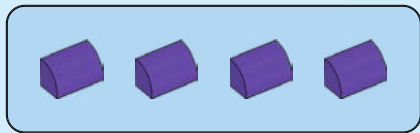

19

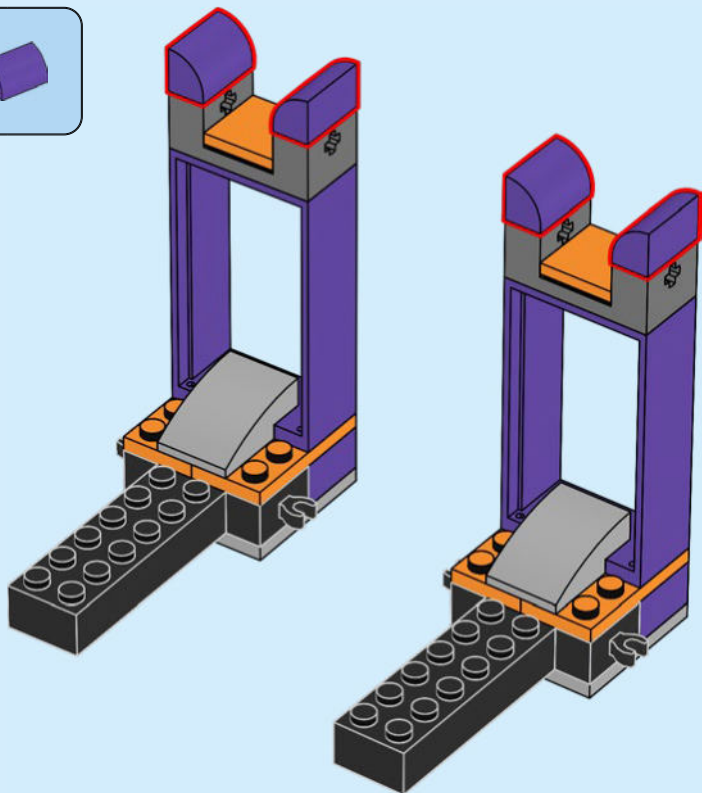

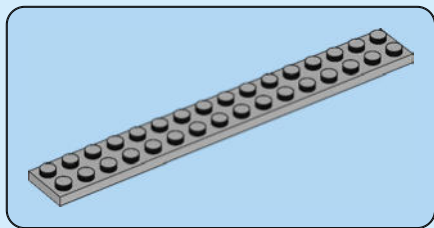

20

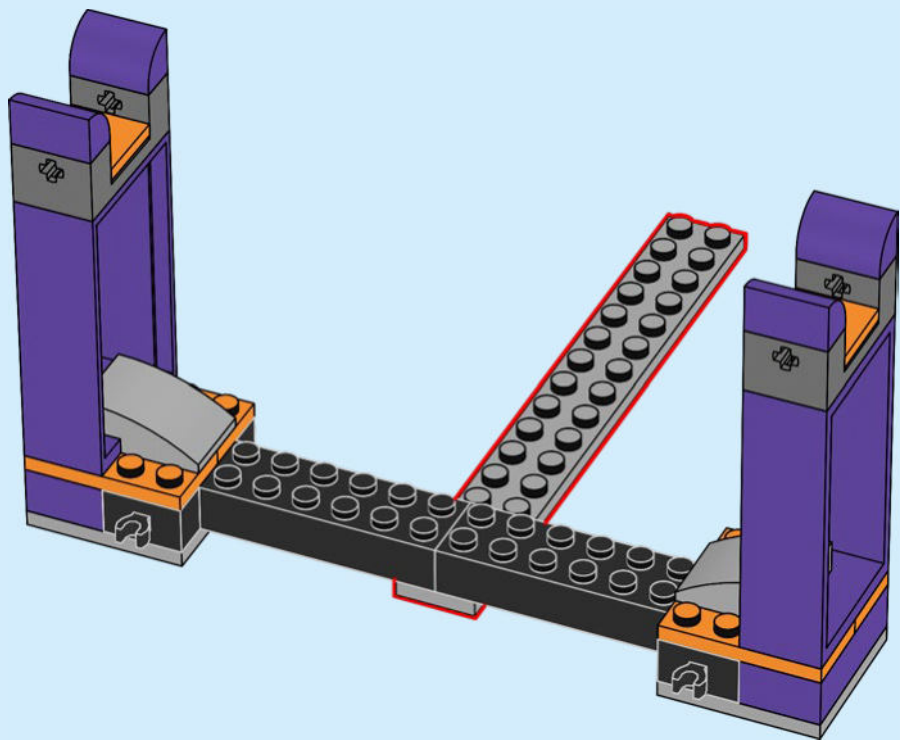

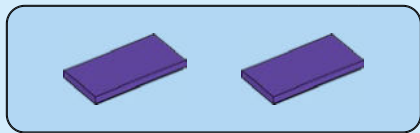

21

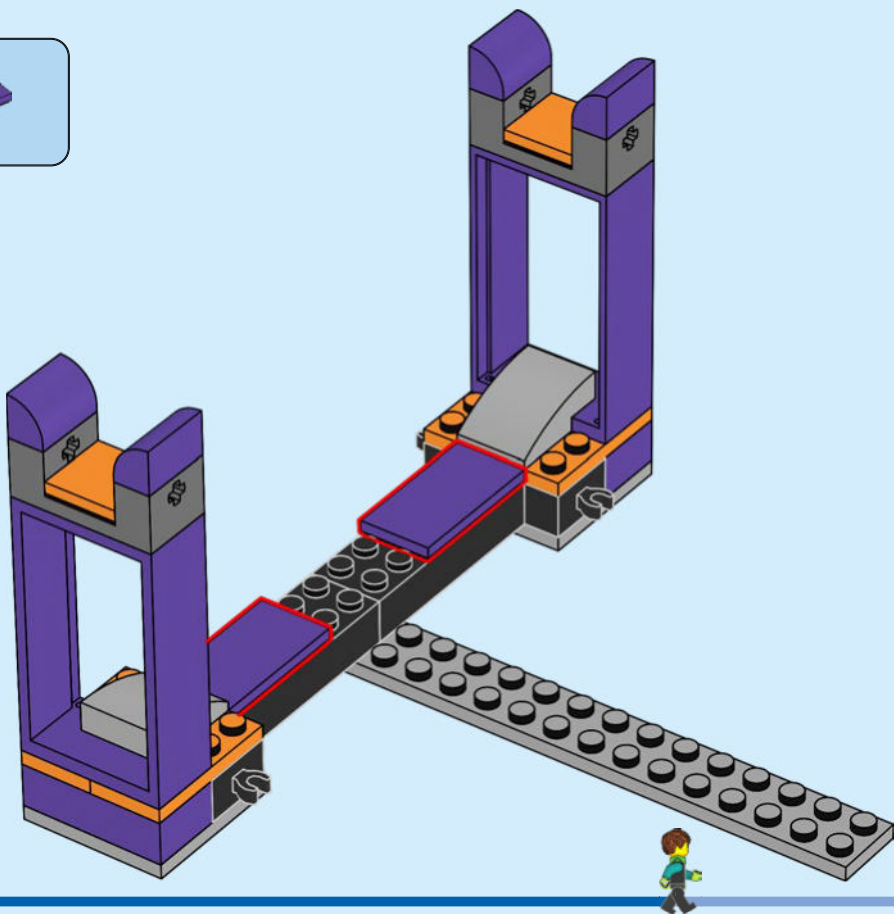
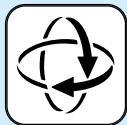

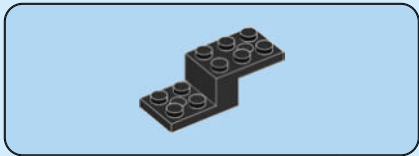

22

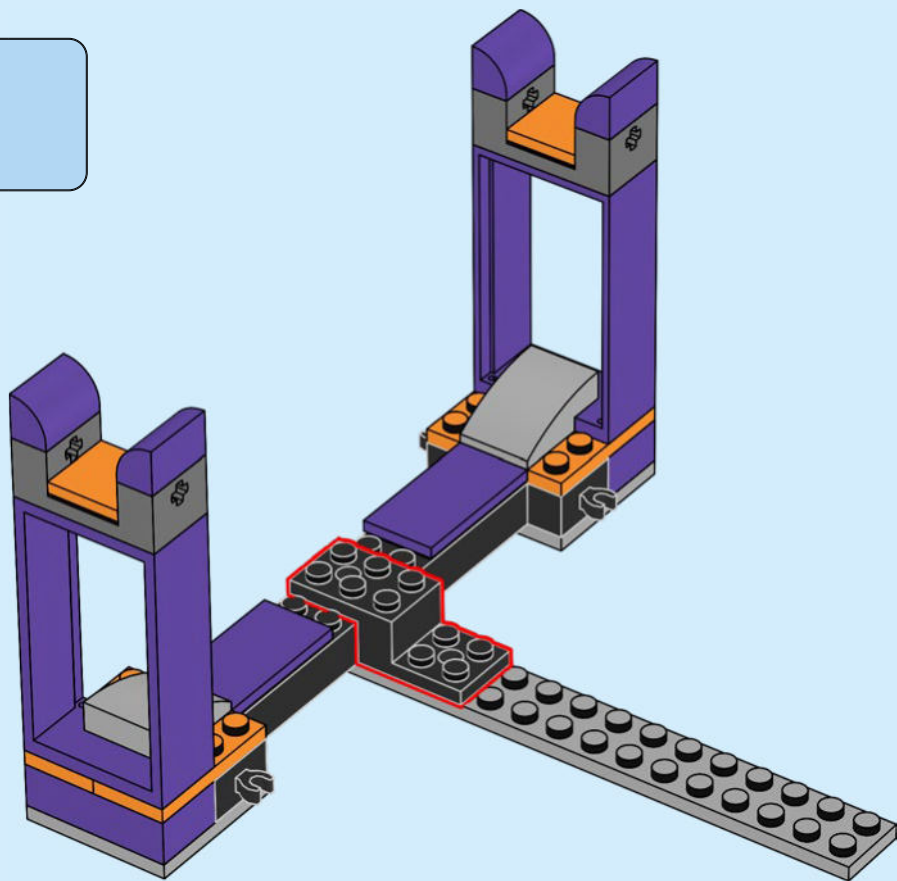

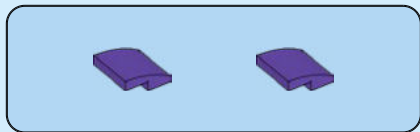

23

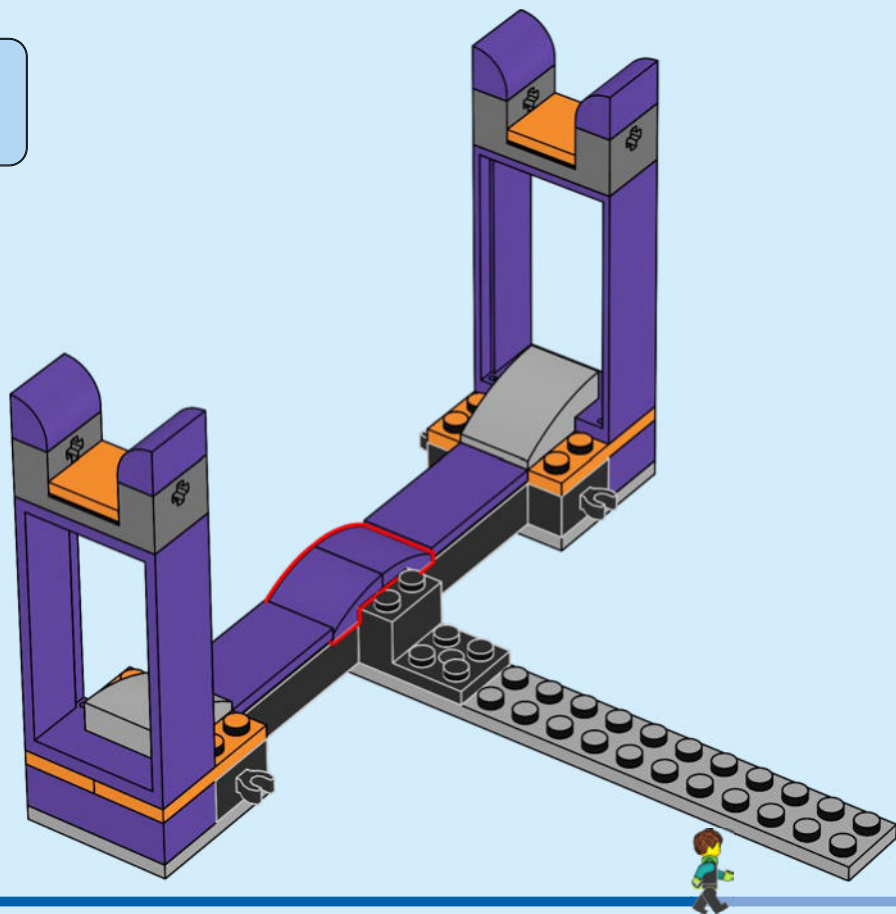





24

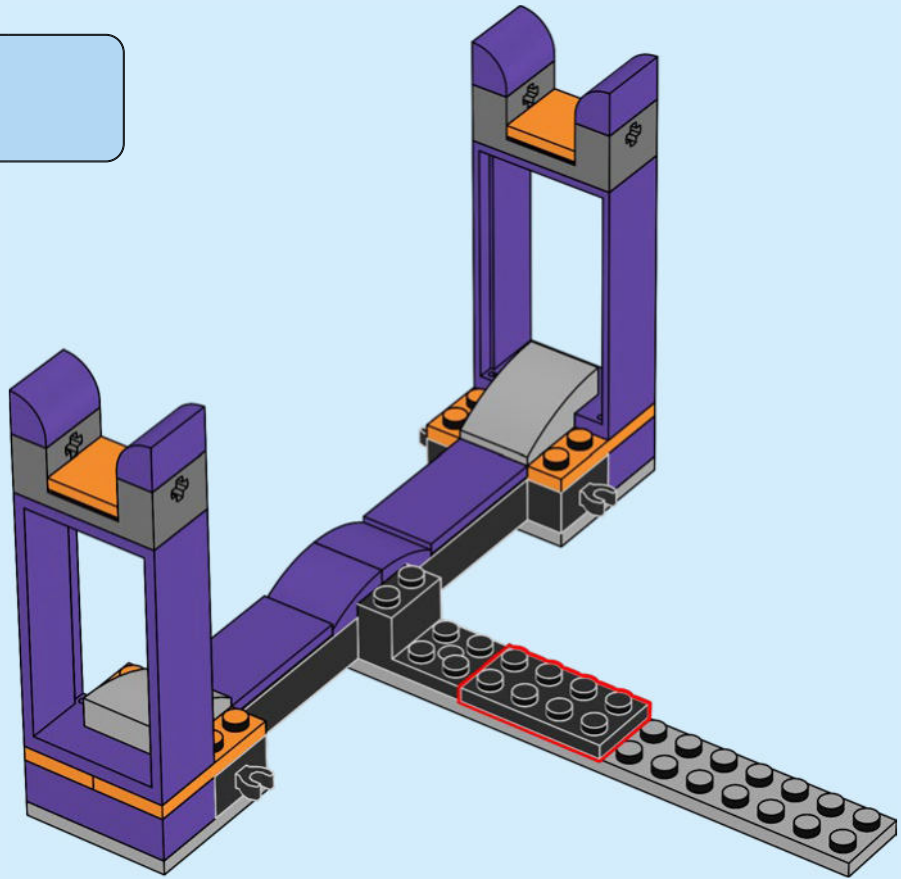

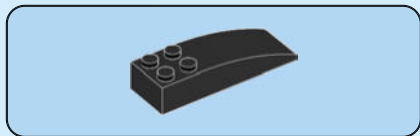

25

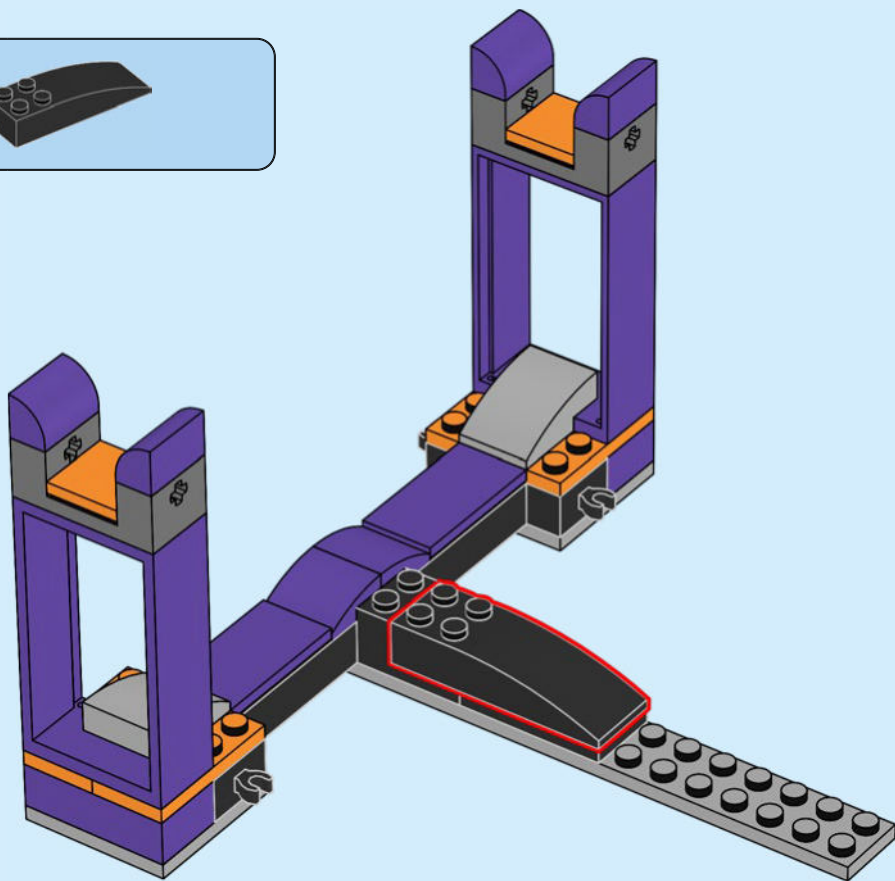

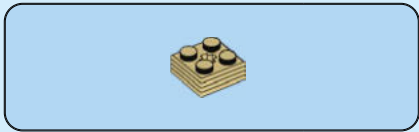

26

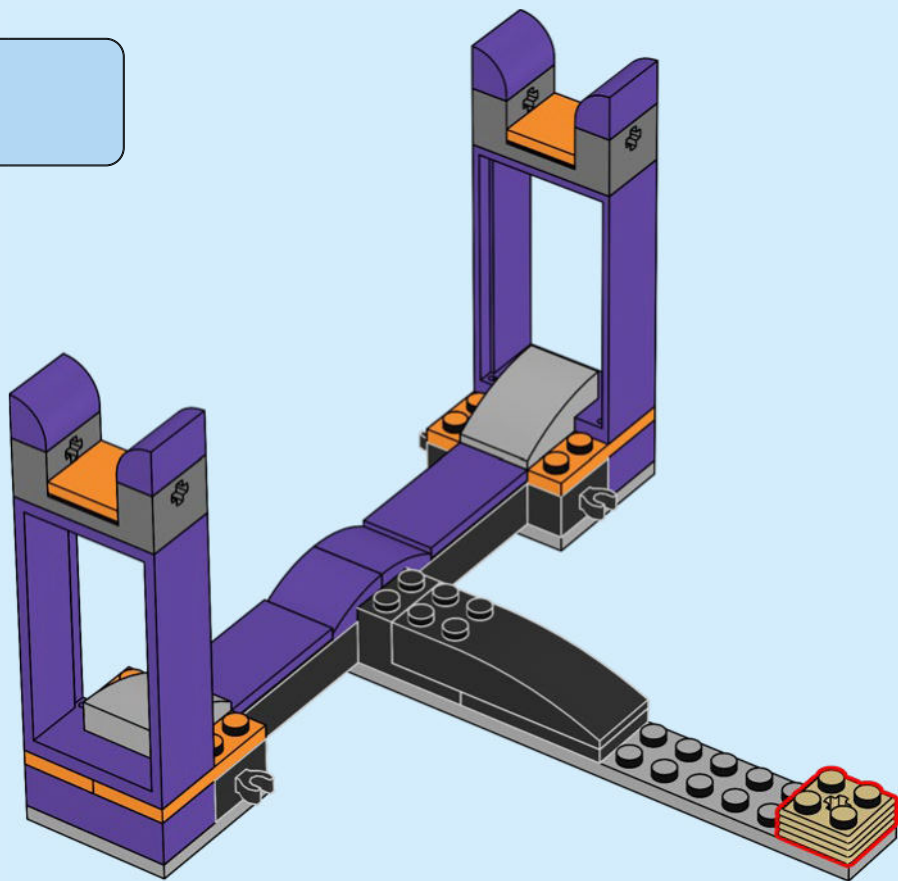

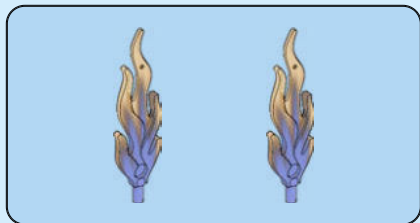

27

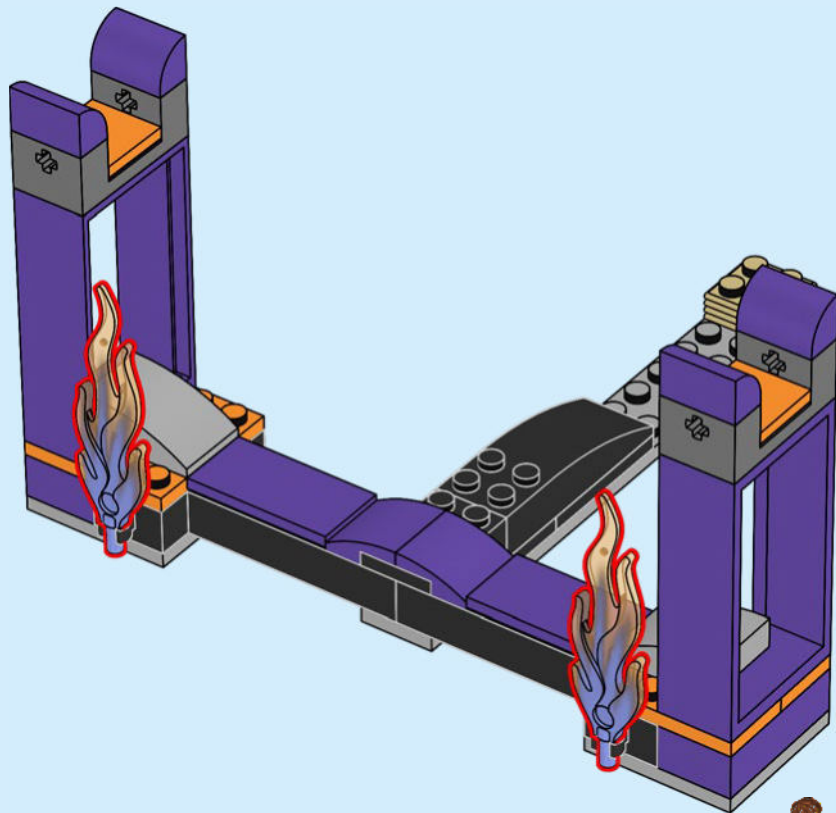
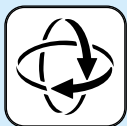

28

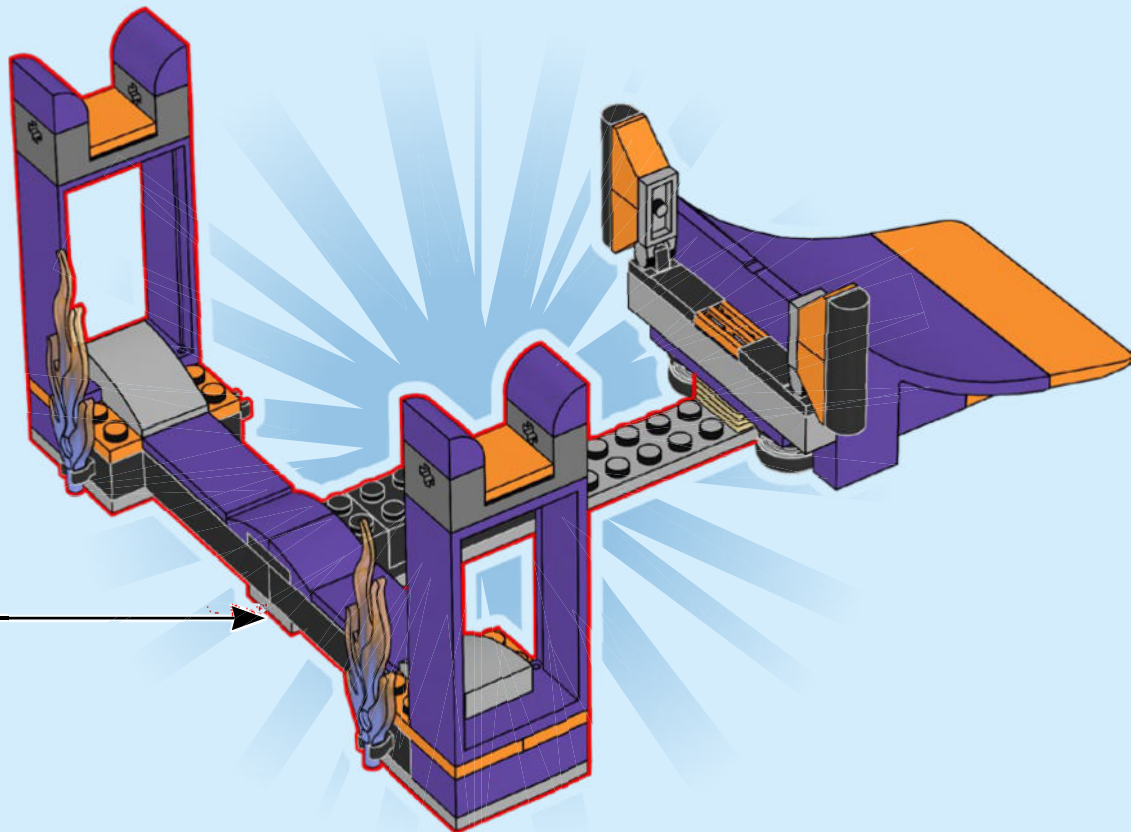

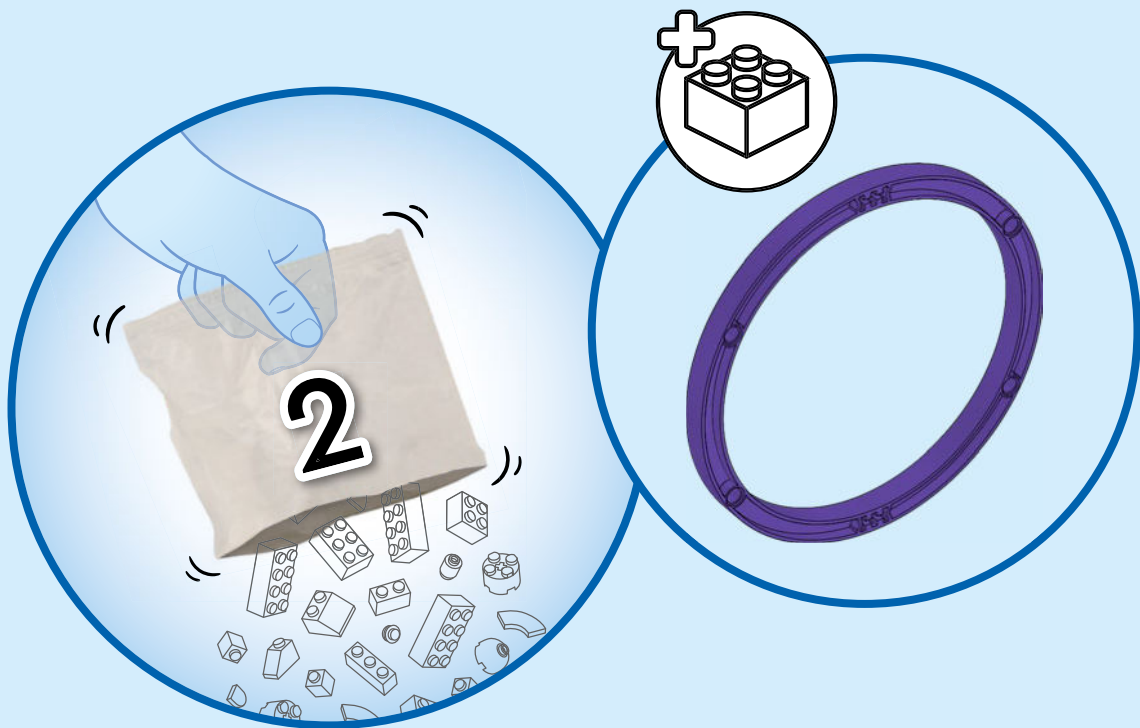

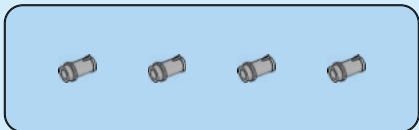
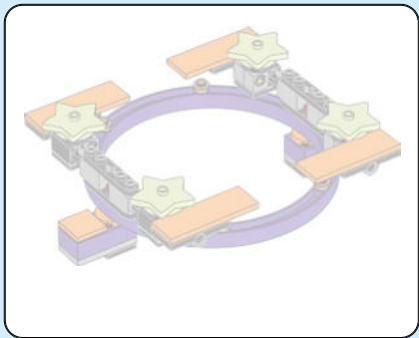

29

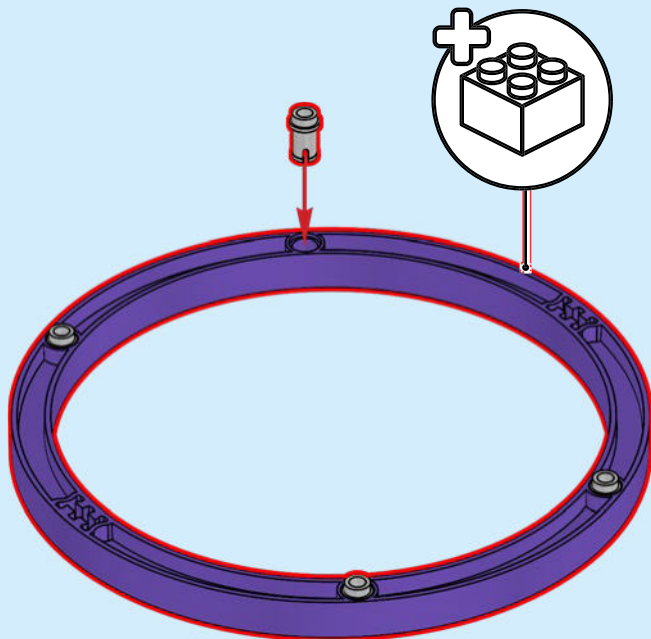

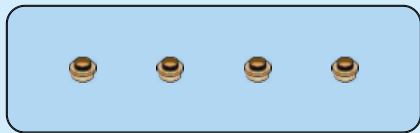

30

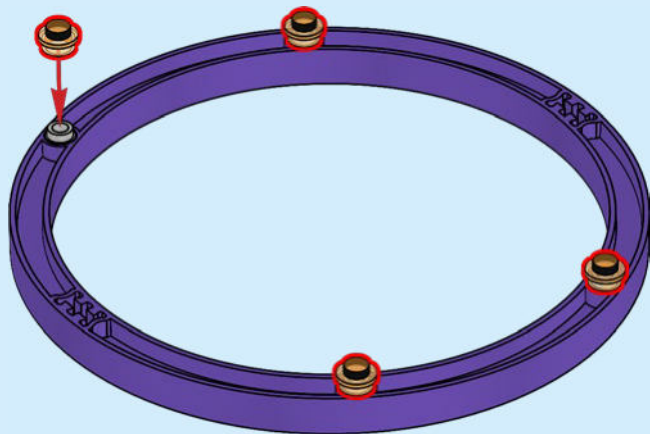





31



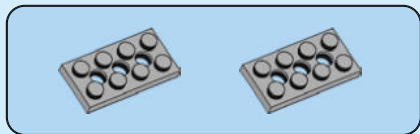

32

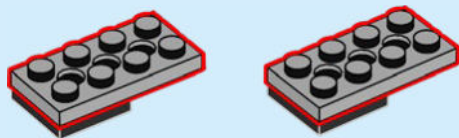

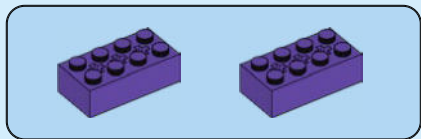

33

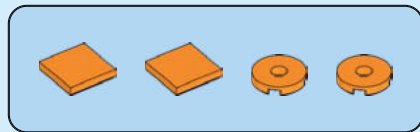
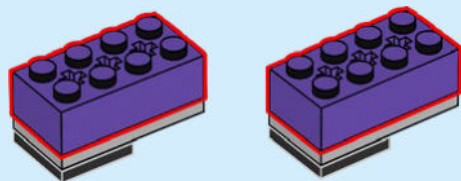

34

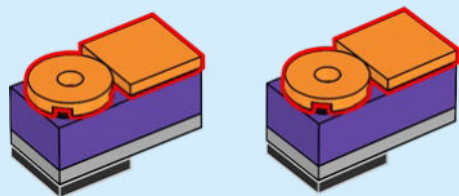

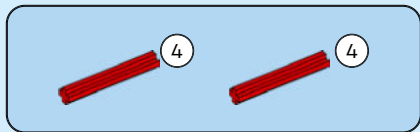

35

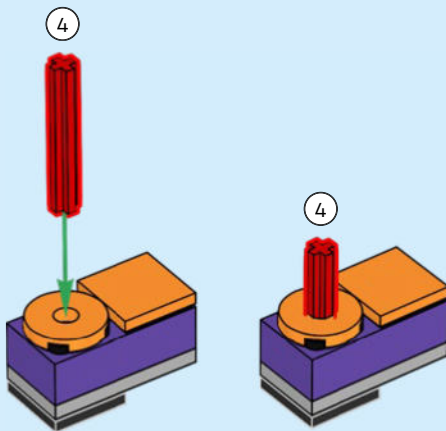

36

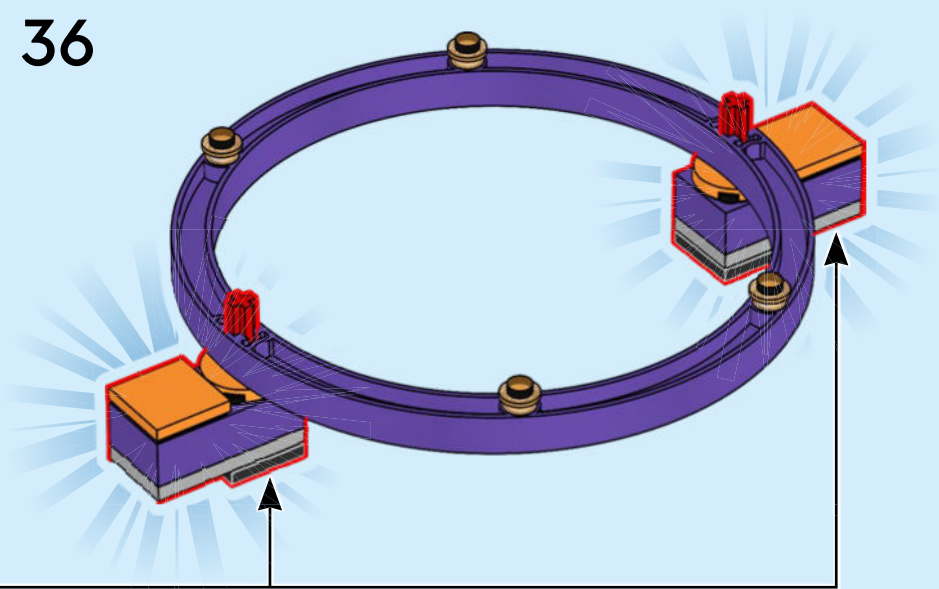

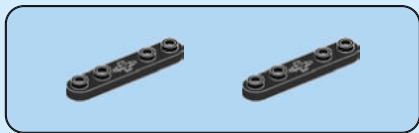
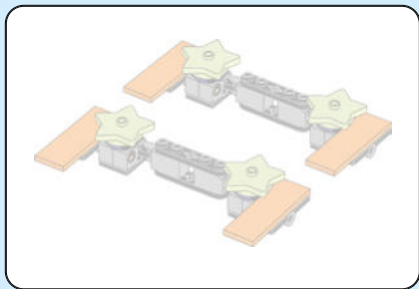

37

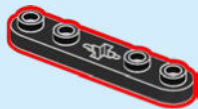

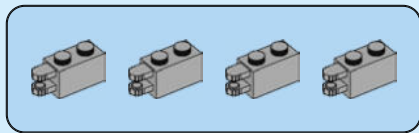

38

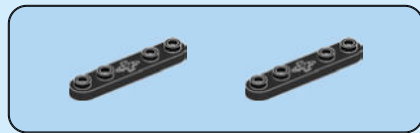
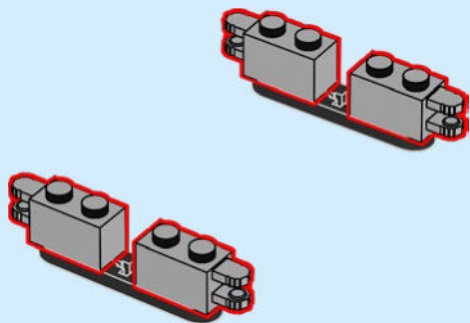

39

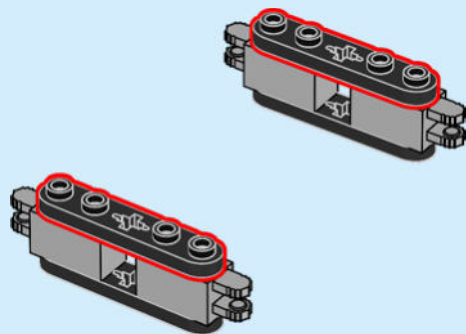



40





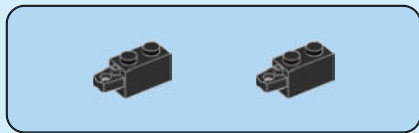

41

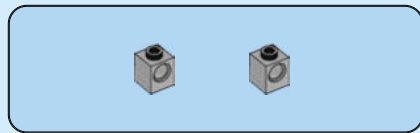
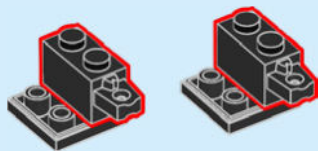

42

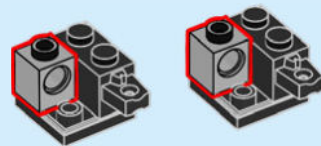



43

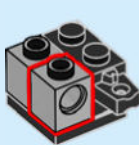

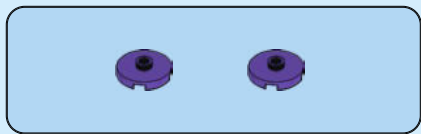

44

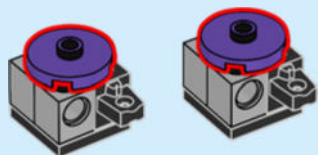

45

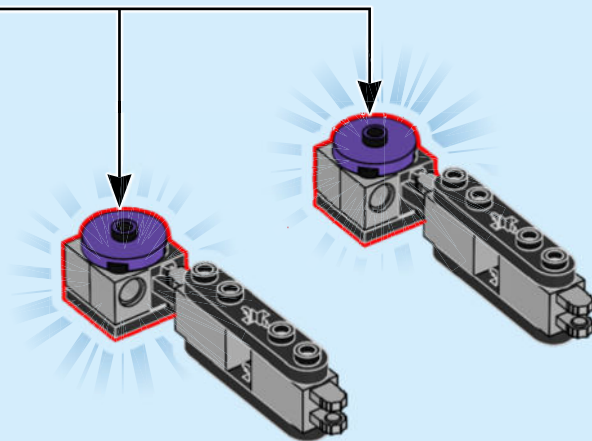



46



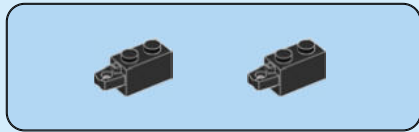

47

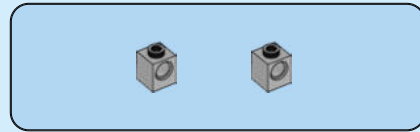
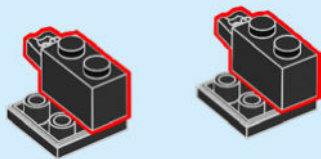

48

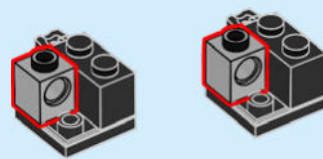



49

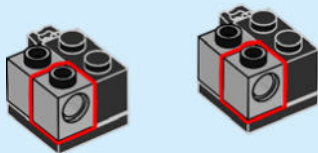

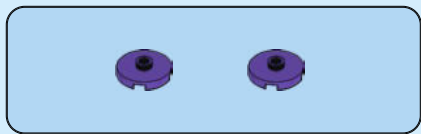

50

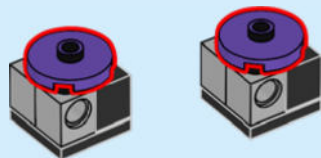

51

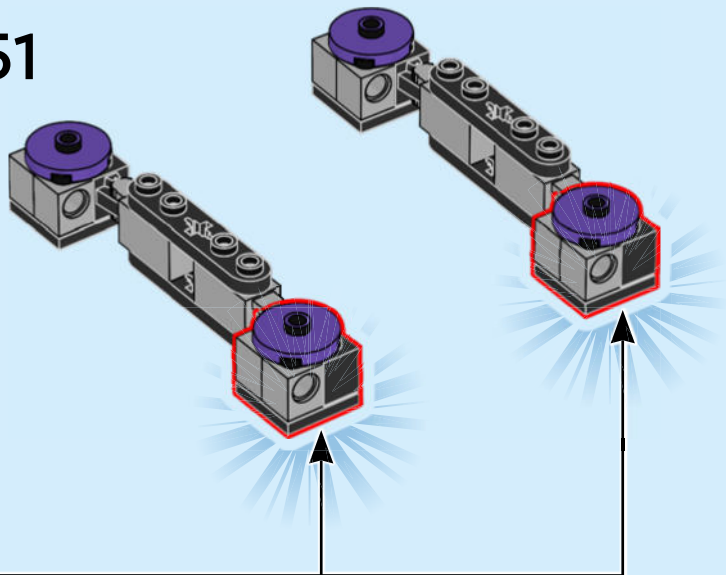

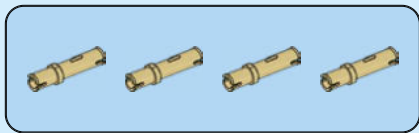

52

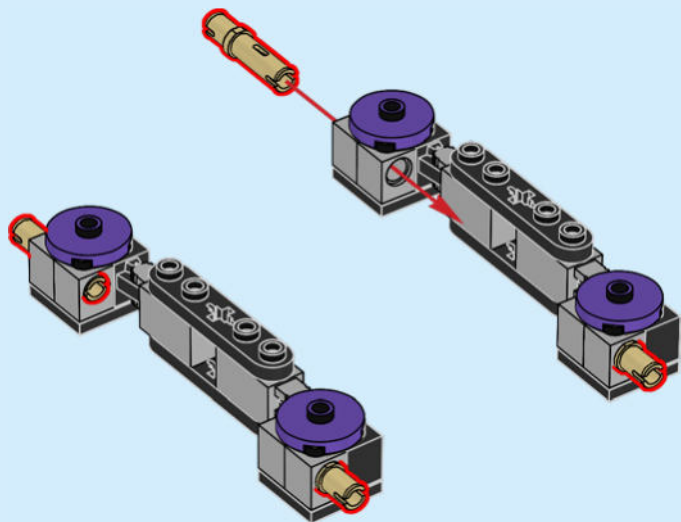



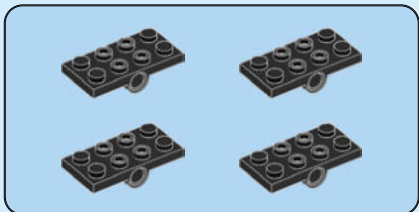
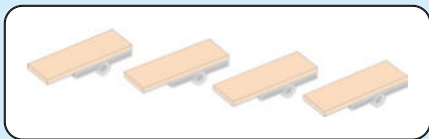

53

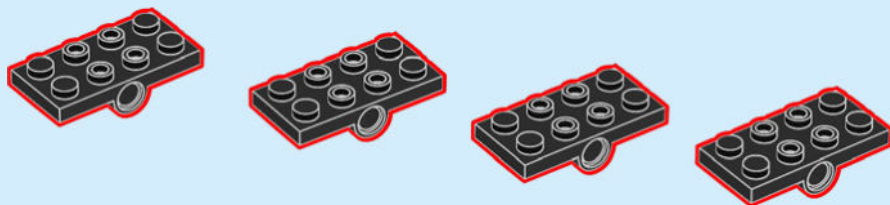

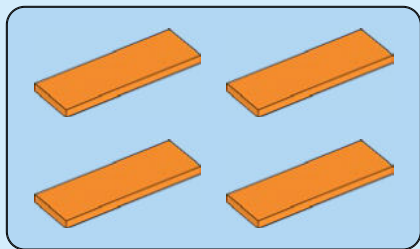

54

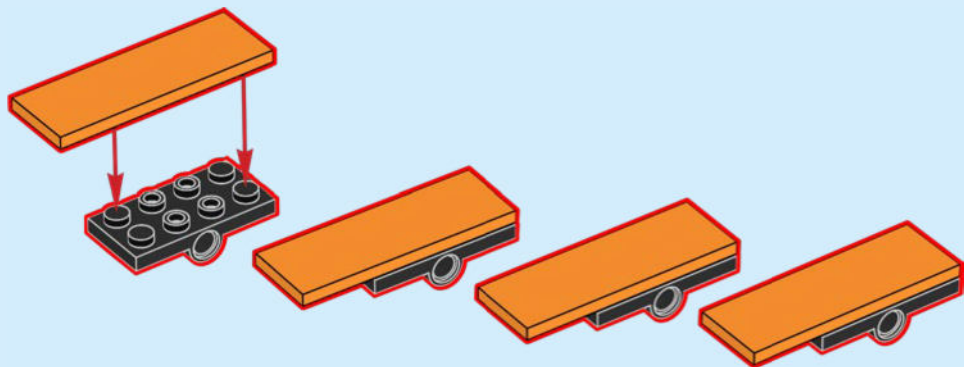

55

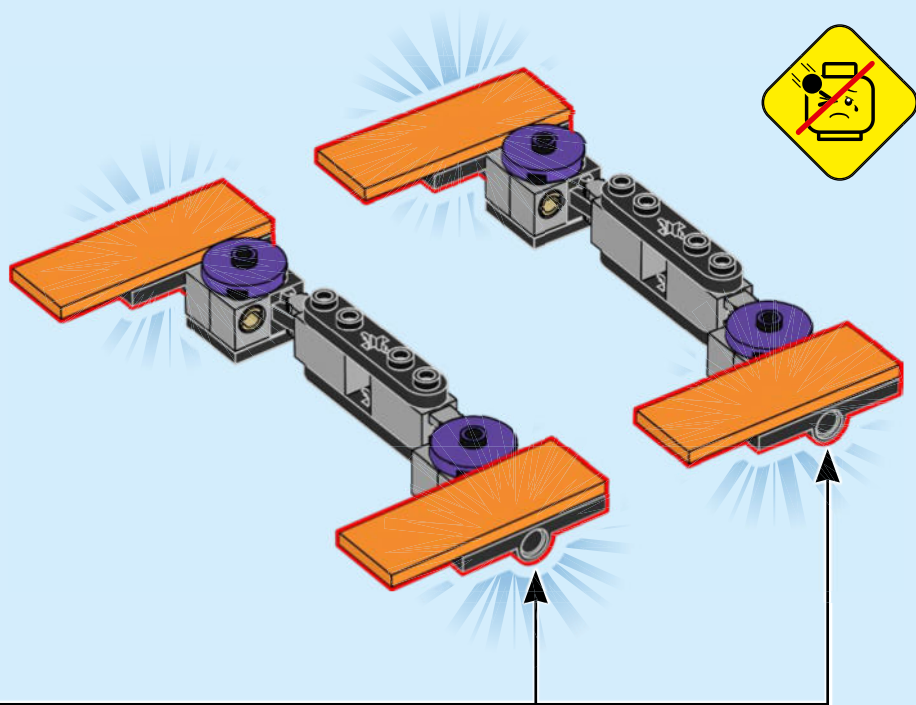

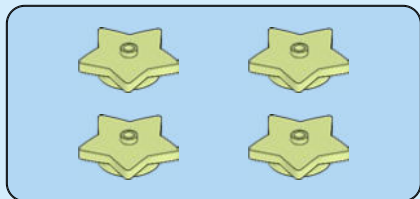

56

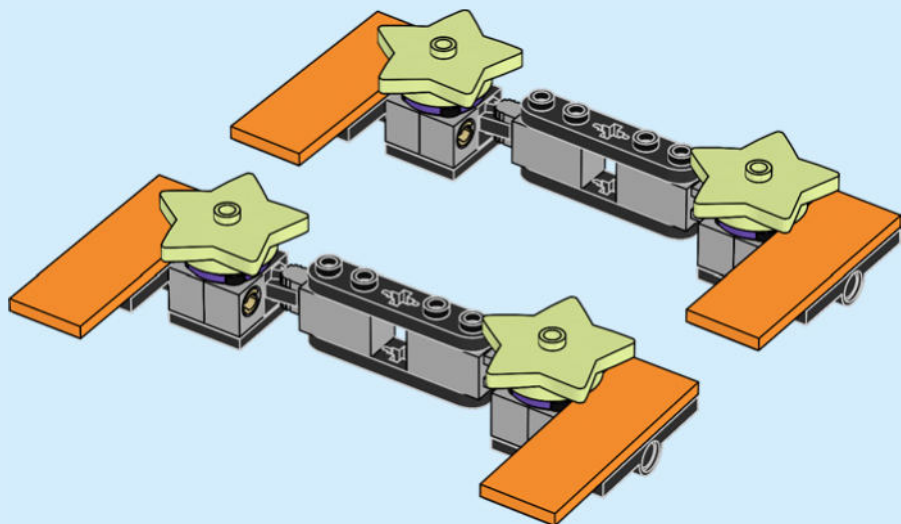

57

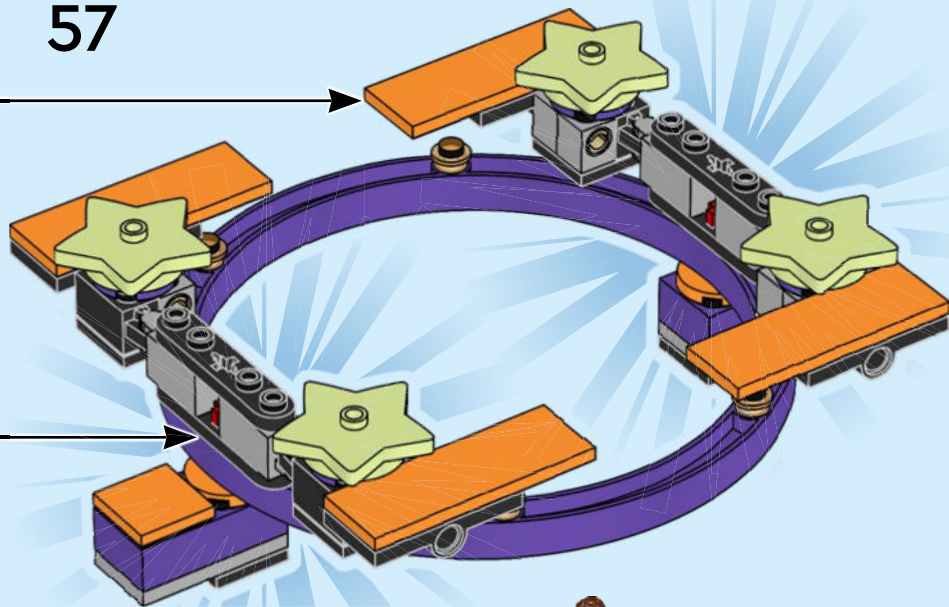

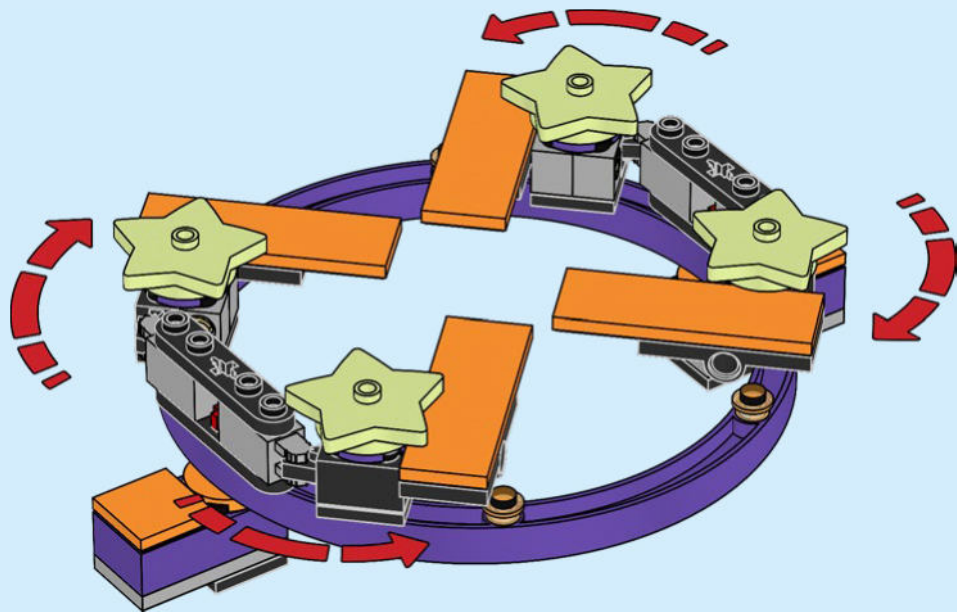

59

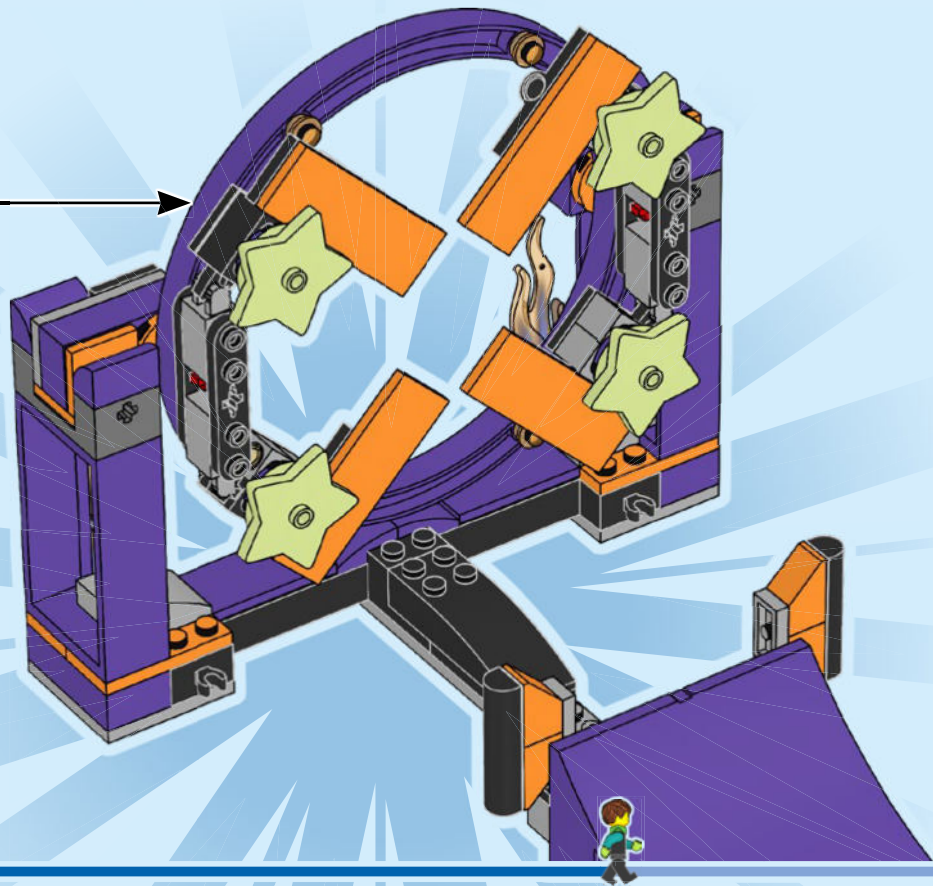

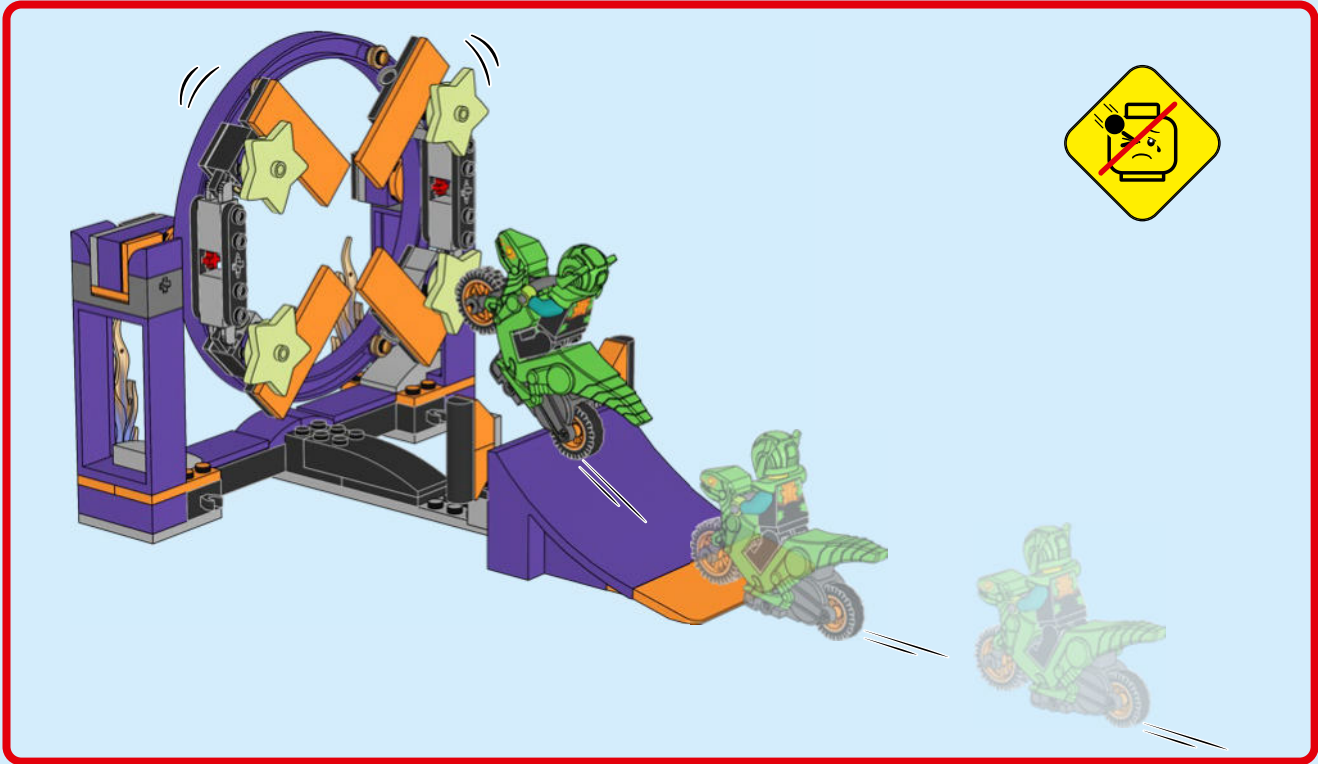



60

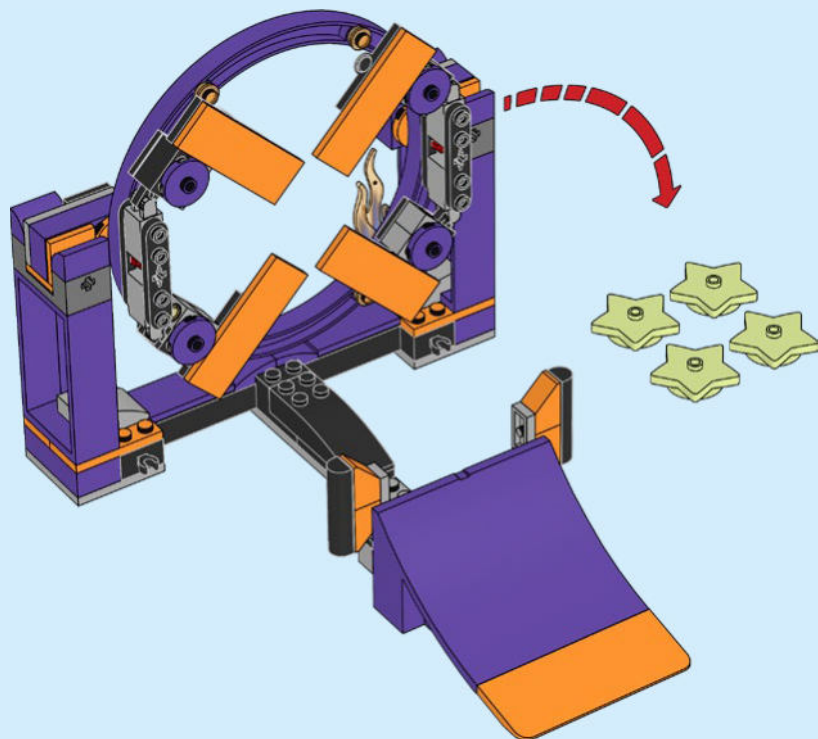

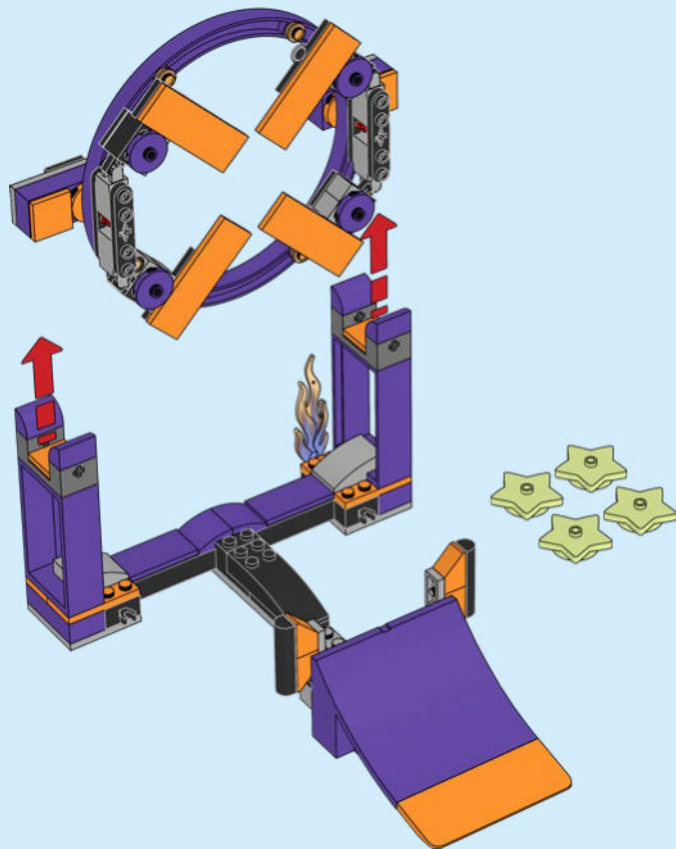

62

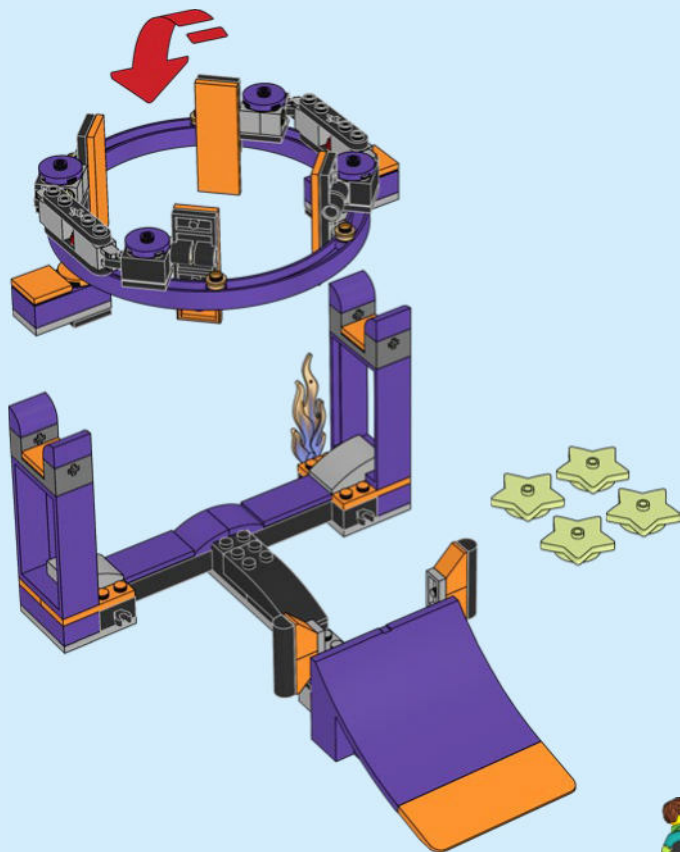

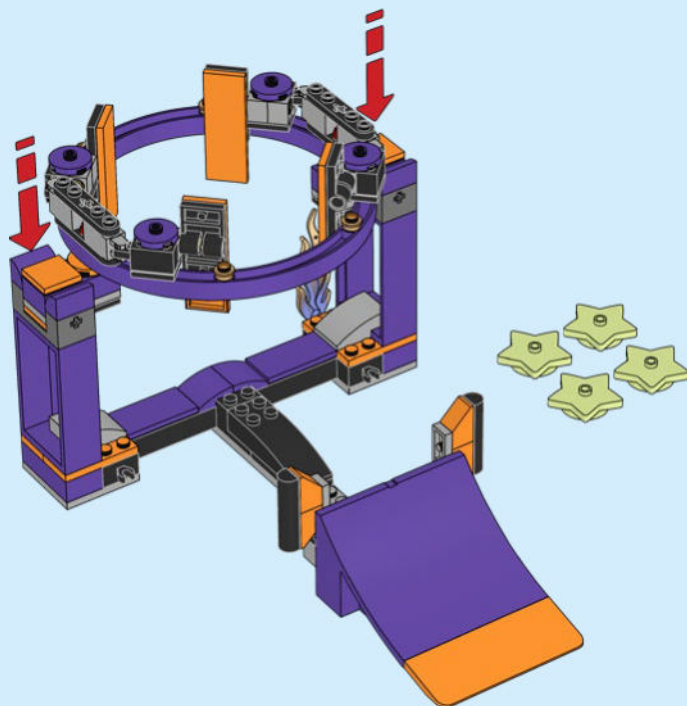

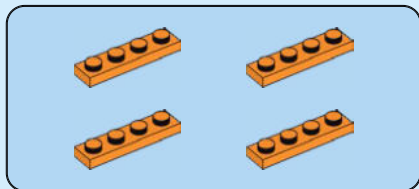
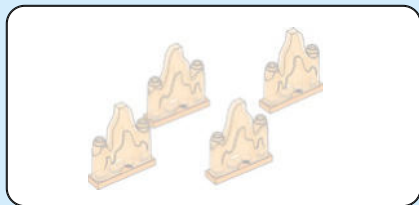

64

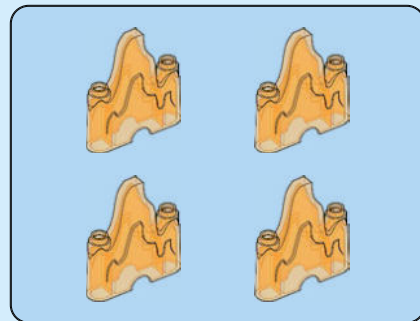
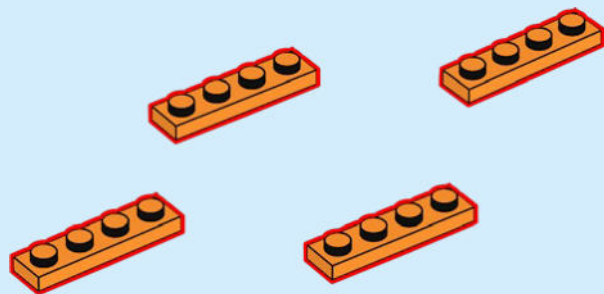

65

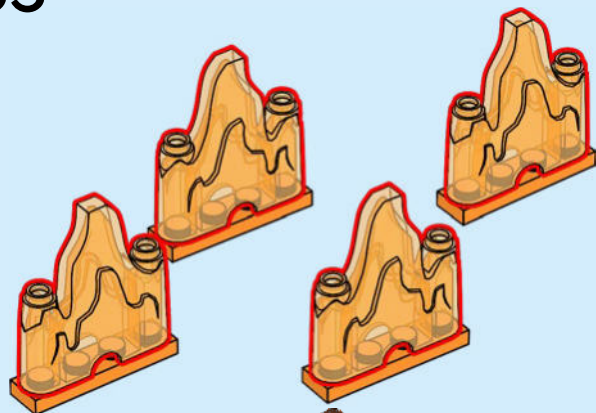

66

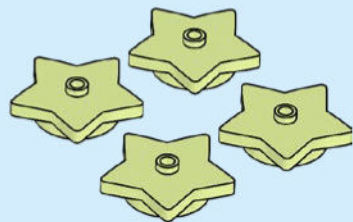
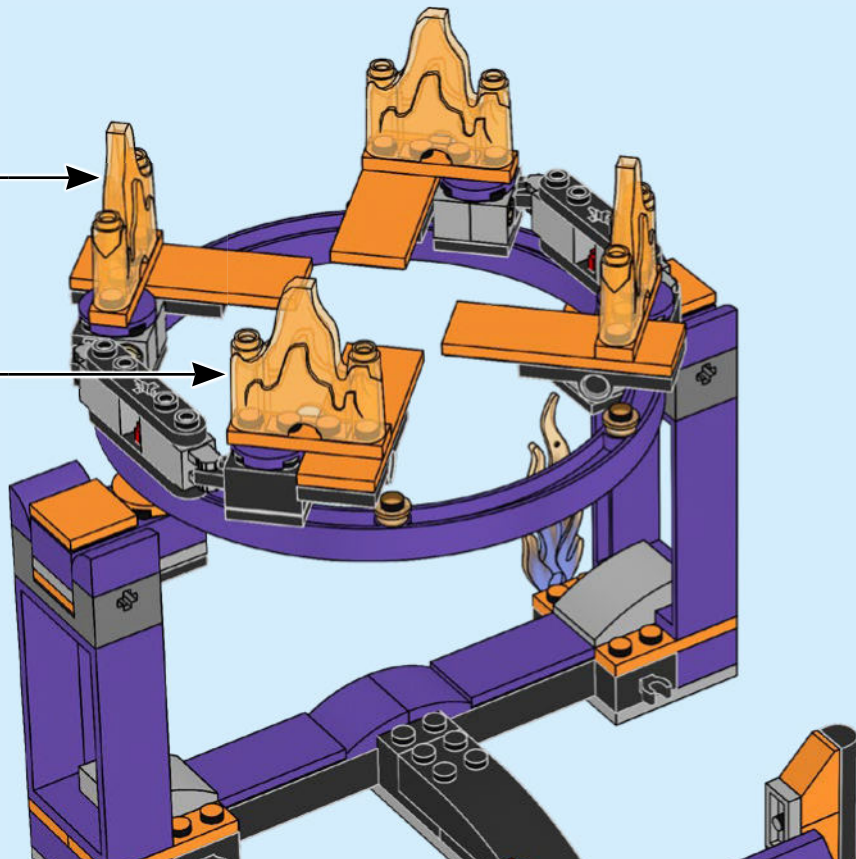

67

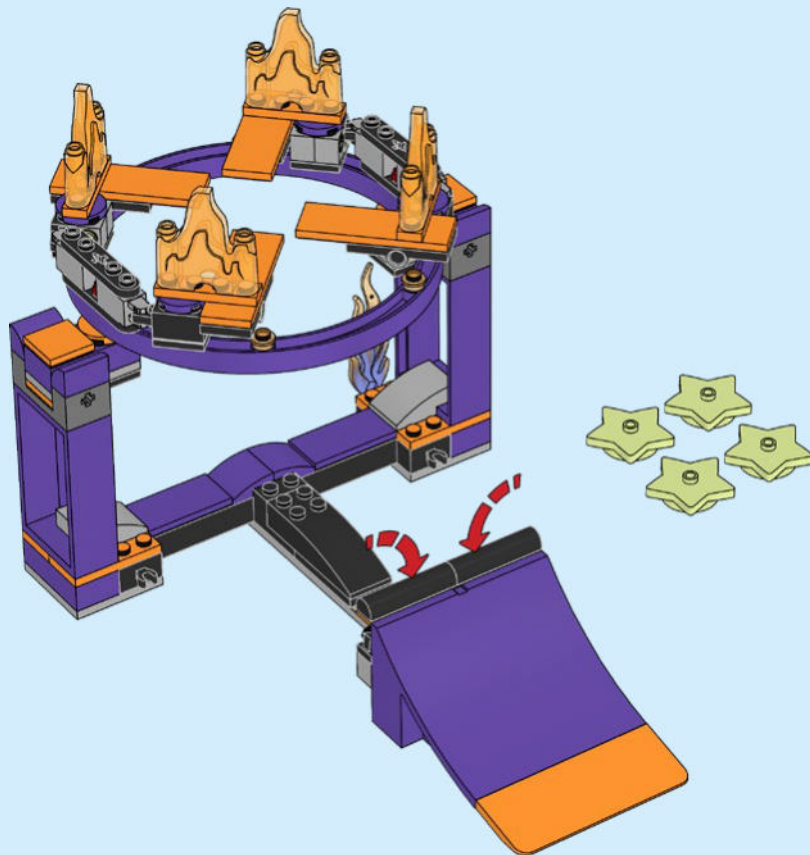

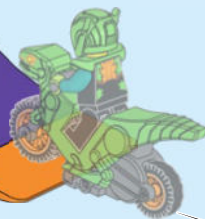
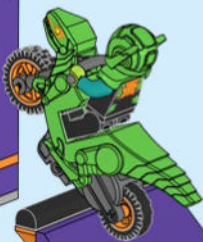
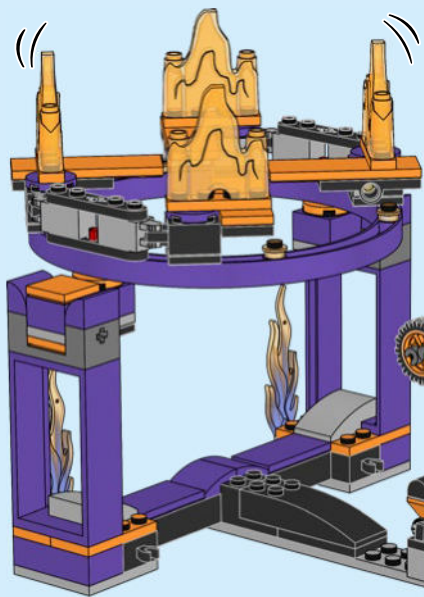



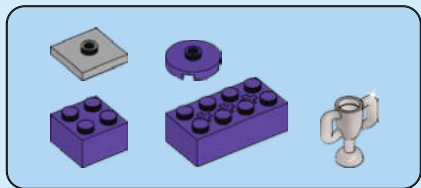

68

1

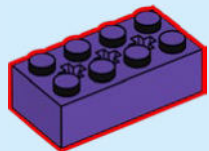

2

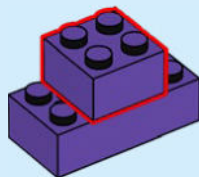

3

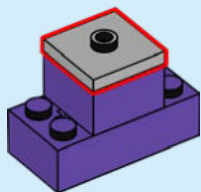

4

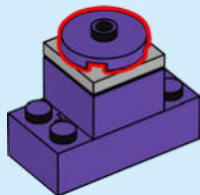

5

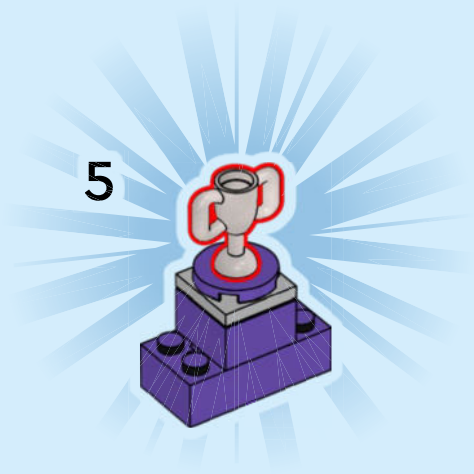



**LEGO**

**CITY**



**STUNTZ**



# CITY



60387



60389



60383



60384



60385



1x  
6429575



1x  
6437232



2x  
4516843



2x  
6147052



4x  
6240227



4x  
6330197



2x  
6370959



2x  
6252373



1x  
6411000



4x  
6325390



4x  
6263485



4x  
6194233



1x  
6064174



4x  
4616279



1x  
6429572



4x  
4118782



2x  
6396460



6x  
6013867



4x  
6280168



1x  
6397621



4x  
4158355



8x  
4211535



2x  
6265712



1x  
4180548

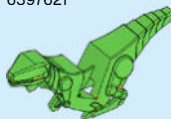

1x  
6429576

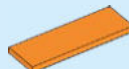

4x  
6387565



2x  
6132207



1x  
6039194

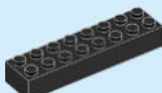

2x  
6037390



1x  
4125254



1x  
6338339



4x  
6267136

4x  
4211483

2x  
6267048

1x  
6126082

2x  
4211444

2x  
4243797

1x  
4211392

1x  
4211486

1x  
6417264

1x  
6438632

4x  
6437187

1x  
4261908

2x  
6335115

1x  
6391388

1x  
4653960

4x  
6264050

2x  
6182217

5x  
6261501

2x  
6167472

5x  
6244920

1x  
6437186

2x  
6436436

1x  
6436435

1x  
6283875

1x  
6330903

4x  
6321305

2x  
6129995

 [LEGO.com/service](https://www.LEGO.com/service)



4

YOU COULD **WIN**



Scan this QR code or go to **LEGO.COM/PRODUCTFEEDBACK** and give us your short feedback about this LEGO® set for a chance to win a cool LEGO prize.

Terms and Conditions apply\*

**DE: Du könntest GEWINNEN.** Es gelten die Teilnahmebedingungen\* **FR: Tu pourrais GAGNER.** Des conditions s'appliquent\* **IT: Potresti VINCERE tu.** Termini e condizioni sono applicabili\* **ES: Puedes GANAR.** Aplican términos y condiciones\* **PT: Poderá GANHAR.** Aplicam-se termos e condições\* **JA: プレゼント付き! 利用規約が適用されます\*** **ZH: 轻松获奖. 条款和条件适用\*** **KO: 상품의 주인이 되어보세요. 소정의 약관이 적용됩니다\*** **RU: Вы можете ВЫИГРАТЬ.** Действуют положения и условия\* **PL: Szansa na WYGRANĄ.** Obowiązują warunki korzystania\* **CS: Máte šanci VYHRÁT.** Platí všeobecné smluvní podmínky\* **SK: Máte šancu VYHRAŤ.** Platia všeobecné zmluvné podmienky\* **HU: TE IS NYERHETSZ.** Felhasználási feltételek érvényesek\* **RO: Ai putea CÂȘTIGA.** Se aplică termenii și condiții\* **BG: Можете да СПЕЧЕЛИТЕ.** Има определени правила и условия\* **LV: Tu vari LAIMĒT.** Ir spēkā noteikumi un nosacījumi.\* **ET: Sul on võimalus VÕITA.** Kehtivad tingimused\* **LT: Jūs galite LAIMĖTI.** Taikomos sąlygos\*  
\*LEGO.com/productfeedback-terms